

FEA E

-
-
-

D-323

ECHA ICAL DA A

-
-
-
-
-

A I A I G (A = 25 C)

C

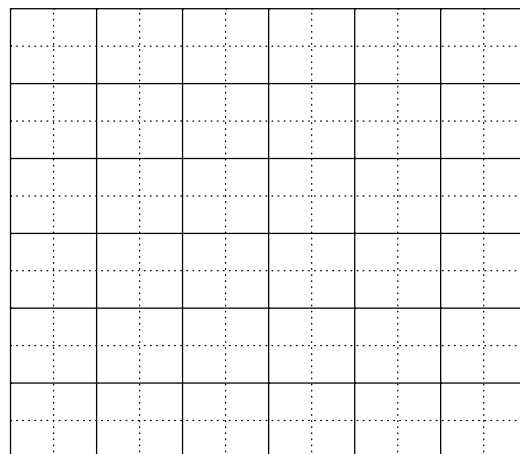
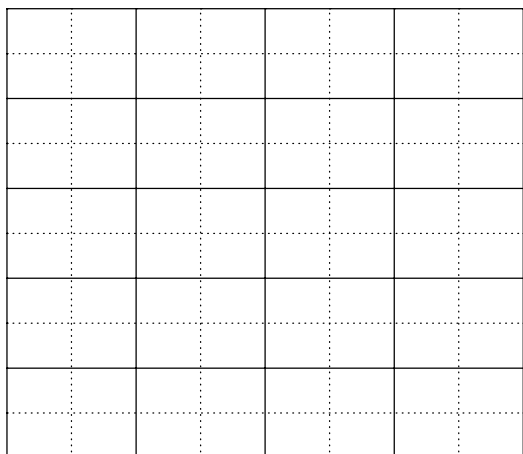
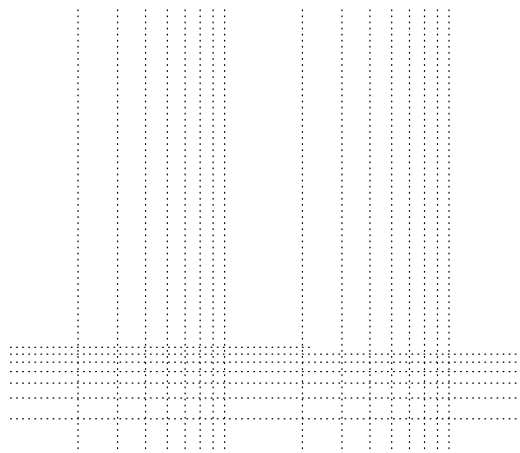

D-323

D

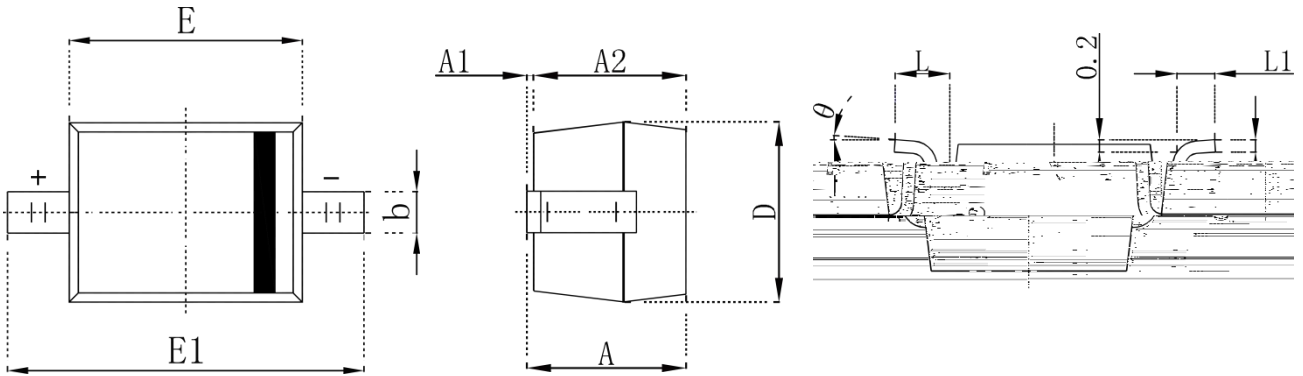

	D		I	
	D	I	D	I

D-323

L

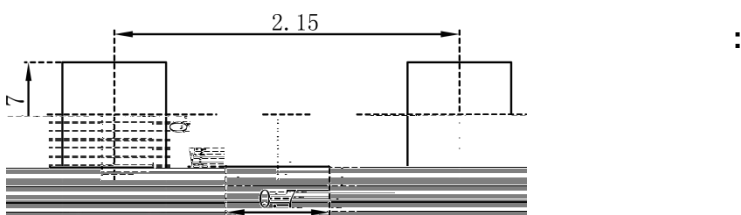

D-323

D-323 E

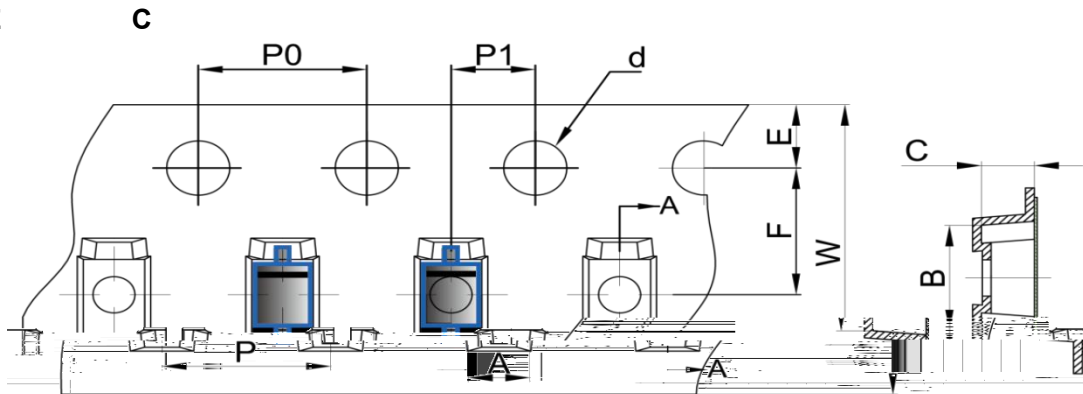

D-323

L

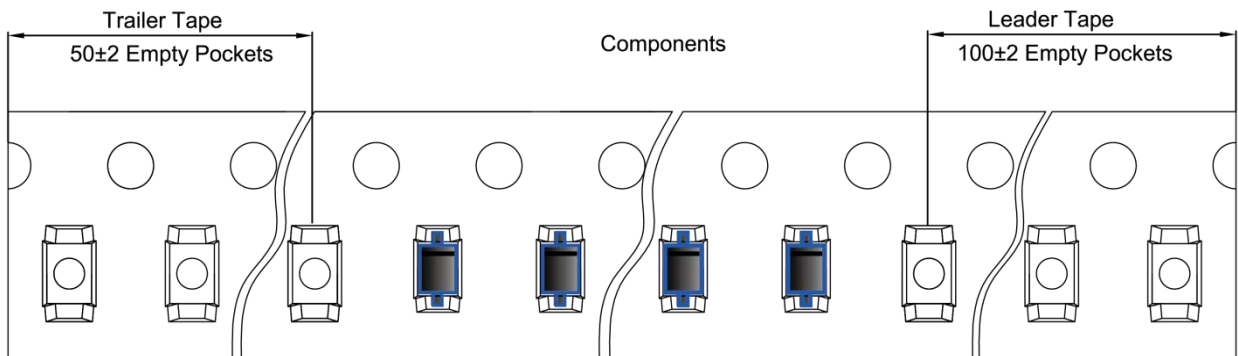

D-323

